

JOB NUMBER: #####
PROJECT MANAGER: #####
WORK: #####
CELL: #####
EMAIL: #####
DESIGNER: #####
WORK: #####
CELL: #####
EMAIL: #####

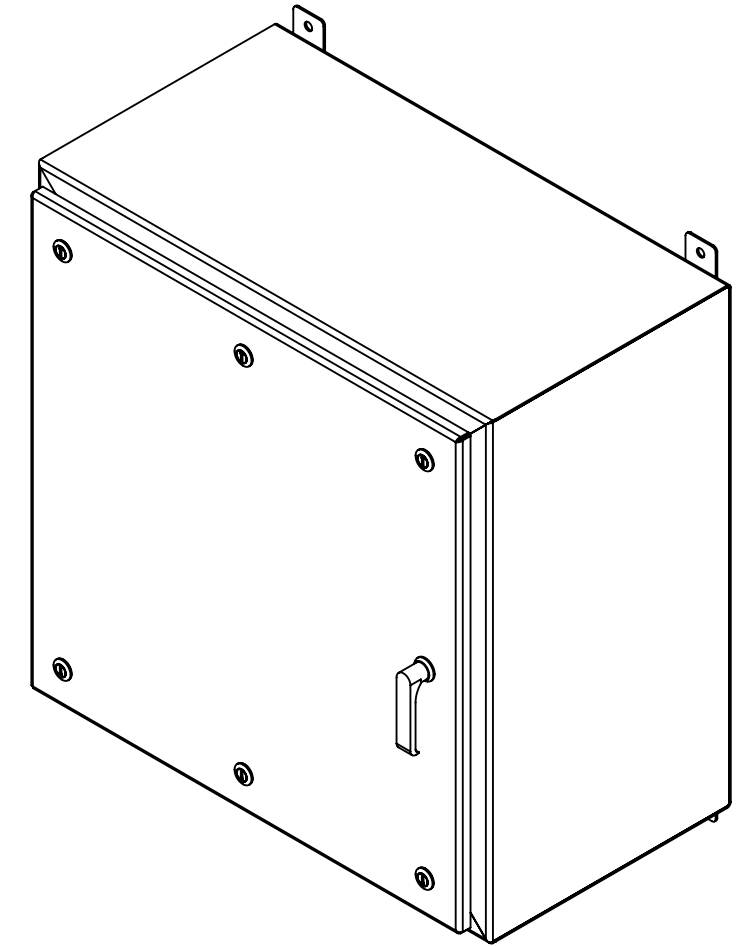
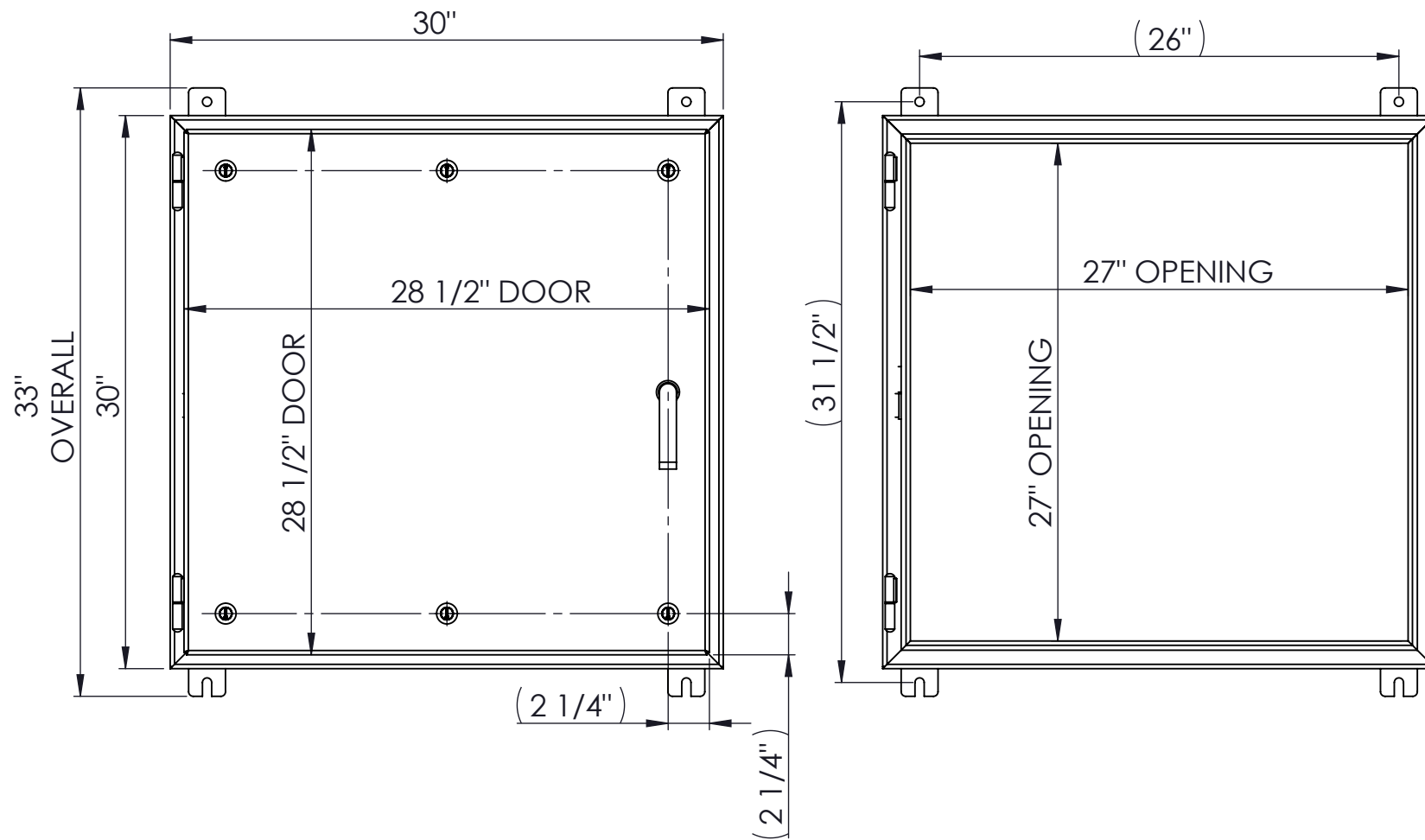

NOTE:

1. ENCLOSURE TO BE FABRICATED FROM 12 GA. SHEET; #4 ONE SIDE; T304
2. EXTERIOR - #4 POLISH; ALL WELDS GROUND AND POLISHED
3. INTERIOR - 2B FINISH
4. **SUB PANEL SIZE** - 26 3/4" x 26 3/4"
5. ALL DIMENSIONS MARKED IN PARENS ARE TYPICAL

HARDWARE:

1. **HINGE** - GUDEN; SSWMO32 FP
2. **QAURTER TURN** - SIERRA PACIFIC; 41-3355T; 12C2C LATCH
3. **HANDLE** - DIRAK: 7-103 QAURTER TURN WITH HANDLE PR20.1 L18

LLC., AND SHALL NOT BE REPRODUCED, COPIED OR USED IN WHOLE OR PART AS THE BASIS FOR THIS DRAWING AND SPECIFICATIONS ARE THE PROPERTY OF MIDWEST STAINLESS PROCESS SYSTEMS THE MANUFACTURE OR SALE OF ITEMS WITHOUT WRITTEN PERMISSION.

ISSUED FOR REVIEW		A	-	-	-
DESCRIPTION		REV.	DATE	BY	ENG
REVISION HISTORY					
 MIDWEST STAINLESS TECHNOLOGIES™ <small>5418 3rd Drive, Suite 10 Menomonie, WI 54751 Ph: (715)235-5472 Fax: (715)235-8484</small>					
SCALE	NTS	CUSTOMER	-		
DATE	-	-			
DRAWN BY	-	DESCRIPTION	-		
CHECKED BY	-	FT-30H30W16D-304UL4X ENCLOSURE			
ENG./APPROVED BY		DRAWING NUMBER		REV.	
SHEET 1 OF 1		FT-30H30W16D-304UL4X		A	